

KLT-X4MF-OS02C10 V1.0 NIR
2MP OmniVision OS02C10 MIPI-Schnittstelle M14
Kein IR Fester Fokus Kameramodul

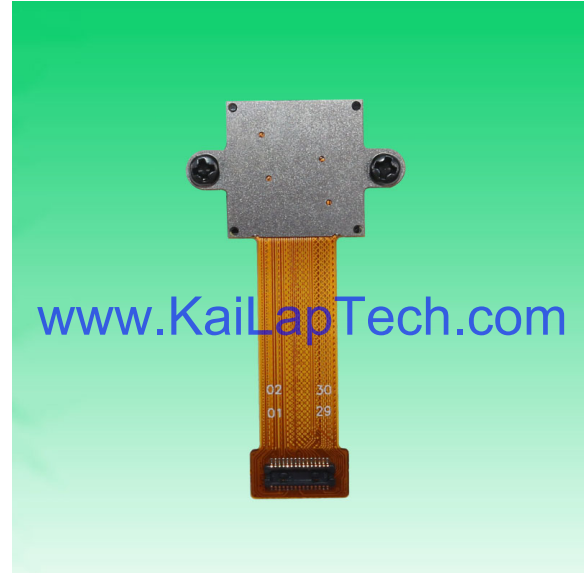

Vorderansicht



Rückansicht

Spezifikationen

Kameramodul Nr.	KLT-X4MF-OS02C10 V1.0 NIR
Auflösung	2MP
Bildsensor	OS02C10
Sensorart	1/2.8"
Pixel Größe	2.9 um x 2.9 um
EFL	2.40 mm
F.NO	2.00
Pixel	1920 x 1080
Betrachtungswinkel	169.0° (DFOV) 144.0° (HFOV) 78.5° (VFOV)
Linsenabmessungen	15.30 x 15.30 x 16.06 mm
Modulgröße	46.72 x 22.00 mm
Modultyp	Fester Fokus
Schnittstelle	MIPI
Autofokus-VCM-Treiber-IC	Keiner
Linsenmodell	KLT-LENS-TRC-2157A2
Linsentyp	Keine IR-Filterlinse
Betriebstemperatur	-30°C to +85°C
Gegenstecker	FH12-24S-0.5SH

KLT-X4MF-OS02C10 V1.0 NIR
2MP OmniVision OS02C10 MIPI-Schnittstelle M14
Kein IR Fester Fokus Kameramodul



Ansicht von oben

www.KaiLapTech.com

Seitenansicht

www.KaiLapTech.com

Untersicht

www.KaiLapTech.com

Gegenstecker

www.KaiLapTech.com

ROHS

PIN SIGNAL

1	AGND
2	AVDD2.8V
3	SDA
4	SCL
5	PWDN
6	RST/XSHUNDN
7	MCP
8	MCN
9	DGND
10	MDP0
11	MDN0
12	DGND
13	MDP1
14	MDN1
15	DGND
16	MDP2
17	MDN2
18	DGND
19	MDP3
20	MDN3
21	DGND
22	DVDD1.1V
23	DOVDD1.8V
24	MCLK

Parameter:

1. Sensor specification:

Image Sensor: OS02C10
 Pixel: 2.9umx2.9um
 Lens Type: 1/2.8
 Important Voltage Description: DVDD1.1V (external power supply),

2. Lens specification:

FOV: 169°(D);144°(H);78.5°(V)
 F/NO: 2.0
 TV distortion: <16%
 Focal length: 2.4mm
 Composition: 6G

Kai Lap Technologies Group Ltd

Designed By Kevin

Model Name: KLT-X4MF-OS02C10 V1.0 NIR

Checked By Aouly

Projection Type:  Third Angle
 Unit: mm
 Material: -----
 Scale: 1:1
 Sheet: 1 of 1
 Version: 1/0

Version	Information	Date
V1.0	First Version	3-17-2021

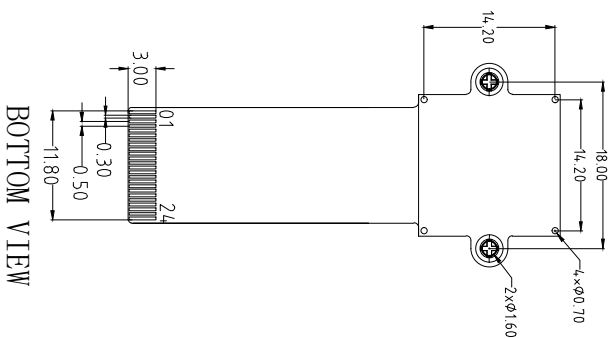
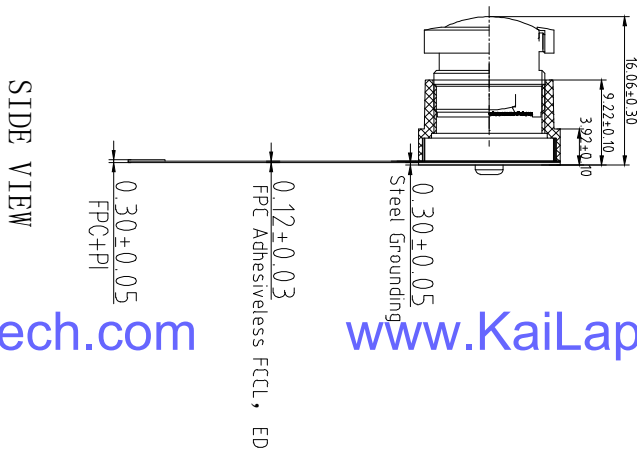
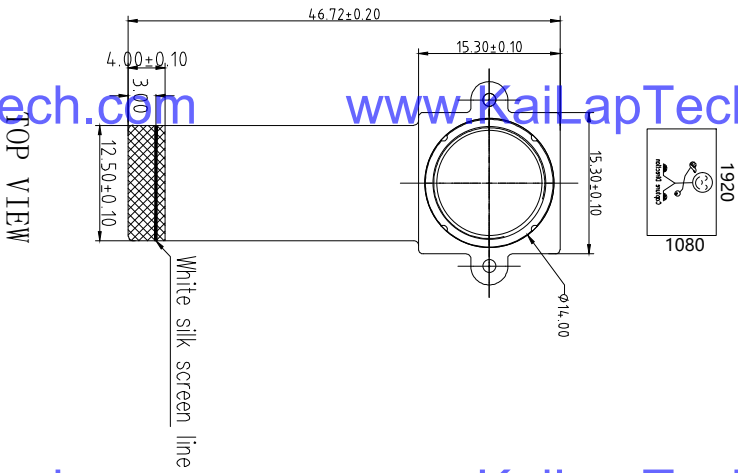

NOTE:
 1.The device slave address:0x6C(w);0x6D(r)

3

2

1

3

2

1



Lens Model: KLT-LENS-TRC-2157A2

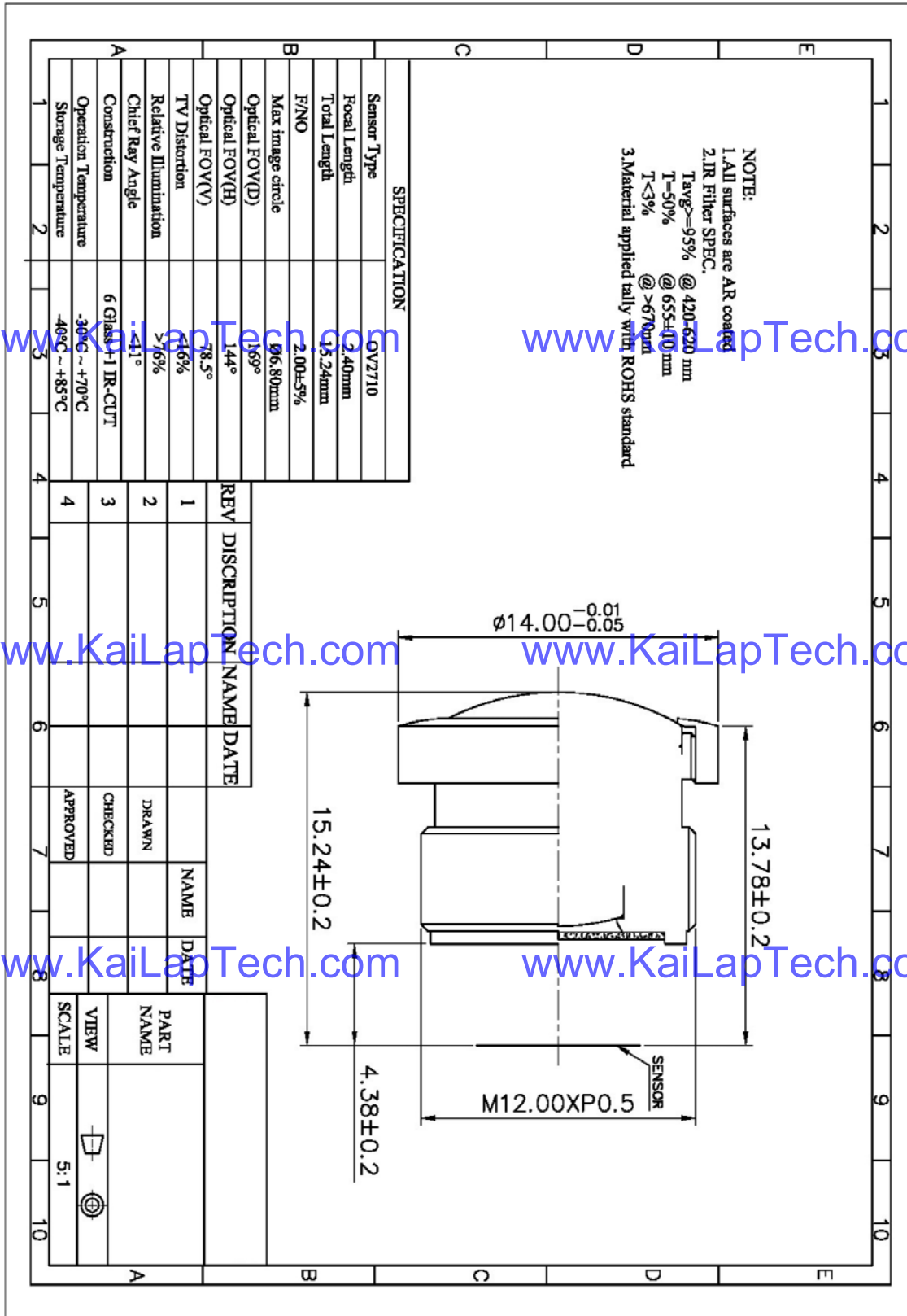

0.5mm and 1mm Pitch Connectors For FPC/FFC

FH12 Series

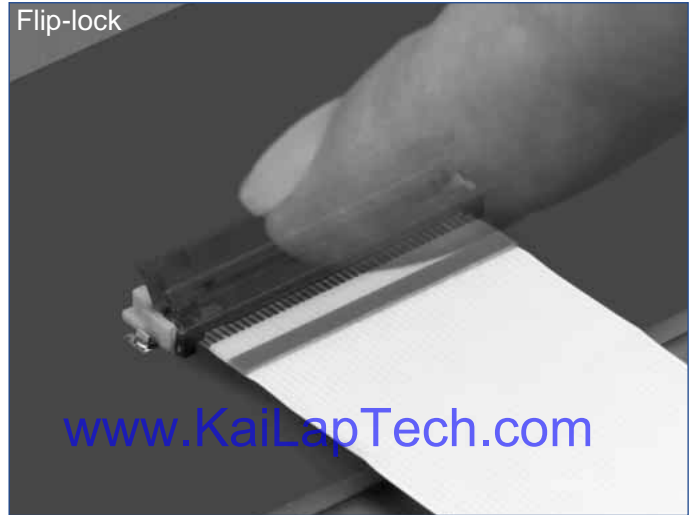
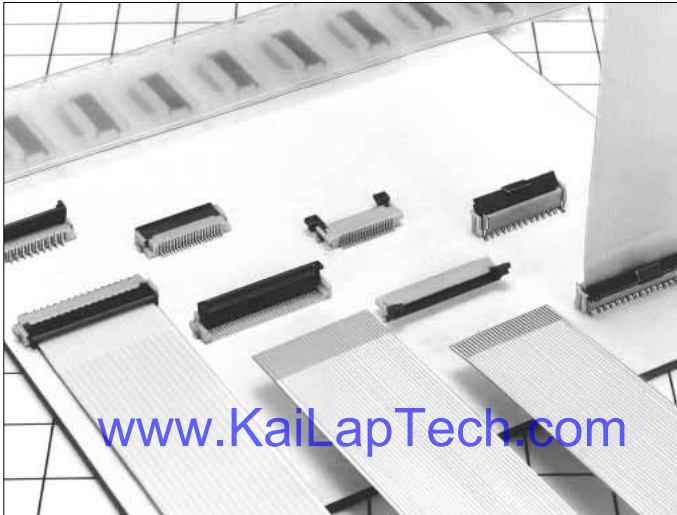

■ Features

1. Ease of Use and Space Savings

Only one finger or 6.9N (Newtons) of force is required to lock Hirose's rotational actuator (flip-lock) as compared to using 2 fingers and 39.2N to close a FFC/FPC connector from our competition.

The Flip-Lock design also allows customers to place 2 or more connectors side by side as there is no need to waste additional board space for a side latch.

2. Strengthened Flip-lock Actuator

The standard Flip-Lock requires only 2.0mm height above the board. A strengthened lock lever is available which only requires an additional 0.4mm.

3. Supports Thin FPC (0.18mm)

Hirose does not require double-sided FPC to have any additional strengthening plate or stiffener and can therefore support a thickness of as little as 0.18mm +/- 0.05.

4. Hirose Ensures Reliability

Hirose's patented half tuning fork contacts maintain the required normal force without relying on the connector housing. With our competitor's conventional products the housing walls support the contact force, which does not provide for long-term reliability.

5. Prevention of Solder Bridge

Excess solder cavity absorbs excessive solder and avoids solder bridging.

6. Three different assembly types

FH12 is offered in Top & Bottom Contact and Vertical Mount and offered in both a 0.5mm contact pitch as well as a 1.0mm contact pitch (bottom contact only).

■ Applications

Notebook computers, printers, PDAs, digital cameras and other compact devices for interconnecting the main circuit board with the LCD, HDD or other device.

Rotating One-touch Mechanism

①

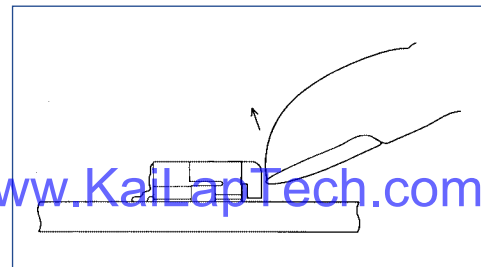

②

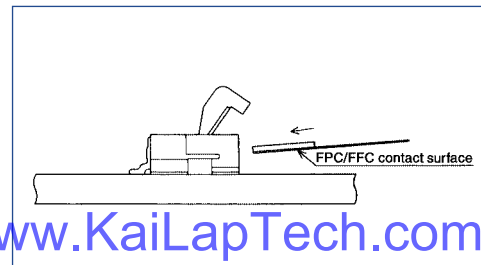

③

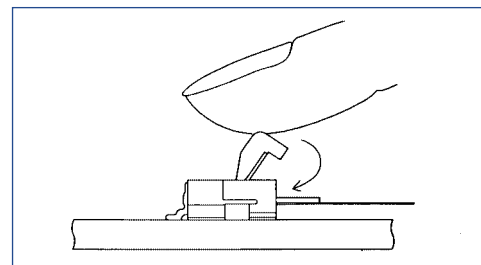

Product Specifications

Rating	Current rating: 0.5A DC (Note 1)	Operating Temperature Range: -40 to +70°C (Note 2)	Storage Temperature Range: -10 to +50°C (Note 3)
	Voltage rating: 50V AC	Operating Humidity Range: Relative humidity, 90% max. (Not dewed)	Storage Humidity Range: Relative humidity, 90% max. (Not dewed)

Applicable FPC	t=0.3±0.05 Gold plated	t=0.18 ± 0.05 for FH12F-*S-0.5SH
----------------	------------------------	----------------------------------

Item	Specification	Conditions
1. Insulation resistance	500M ohms minimum	100V DC
2. Withstanding voltage	No flashover or insulation breakdown.	150V AC/1 minute
3. Contact resistance	50m ohms maximum	1mA
4. Durability (Insertion/withdrawal)	Contact resistance: 50m ohms maximum No damage, cracks, or parts dislocation.	20 cycles
5. Vibration	No electrical discontinuity of 1μs or more Contact resistance: 50m ohms maximum. No damage, cracks, or parts dislocation.	Frequency: 10 to 55 Hz, single amplitude of 0.75 mm, 2 hours in each of the 3 directions.
6. Shock	No electrical discontinuity of 1μs or more Contact resistance: 50m ohms maximum. No damage, cracks, or parts dislocation.	Acceleration of 490 m/s ² , 11 ms duration, sine half-wave waveform, 3 cycles in each of the 3 axis.
7. Humidity (Steady state)	Contact resistance: 50m ohms maximum. Insulation resistance: 50M ohms minimum. No damage, cracks, or parts dislocation.	96 hours at 40°C and humidity of 90% to 95%
8. Temperature Cycle	Contact resistance: 50m ohms maximum. Insulation resistance: 50M ohms minimum. No damage, cracks, or parts dislocation.	Temperature: -40°C → 15 to 35°C → 85°C → 15 to 35°C, Time: 30 → 5 max. → 30 → 5 max. (minutes) 5 cycles
9. Resistance to Soldering heat	No deformation of components affecting performance.	Reflow: At the recommended temperature profile Manual soldering: 350±5°C for 3 seconds

Note 1: When passing the current through all of the contacts, use 70% of the current rating.

Note 2: Includes temperature rise caused by current flow.

Note 3: The term "storage" refers to products stored for long period of time prior to mounting and use. Operating Temperature Range and Humidity range covers nonconducting condition of installed connectors in storage, shipment or during transportation.

Material

Part	Material	Finish	Remarks
Insulator	Polyamide, LCP(60 pos.)	Color : Beige	UL94V-0
Actuator	PPS	Color : Dark brown	
Contact	Phosphor bronze	Gold plated	
Metal Fittings	Brass	Tin plated	

Ordering Information

FH12 **A** - **10** (**4**) - **S** **A** - **0.5** **SH** (**55**)
 ① ② ③ ④ ⑤ ⑥ ⑦ ⑧ ⑨

① Series Name : FH12	⑤ Contact alignment: Single
② Blank : standard type A : Top contact type S : Type with strengthened flip-lock actuator F : Type with 0.18mm FPC End Thickness	⑥ Eccentric direction: Blank : standard type A : Eccentric type
③ Standard type : Number of contacts Eccentric type : Number of contacts in 0.5mm housing	⑦ Contacts Pitch : 0.5mm, 1mm
④ Standard type : Blank Eccentric type : Number of contacts	⑧ Contact type SH : SMT horizontal mounting type SV : SMT vertical mounting type
	⑨ Plating specification (55) : Gold plated

FH12 Series 0.5mm and 1mm Pitch Connectors For FPC/FPC

Series Configuration

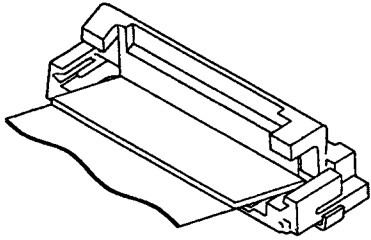
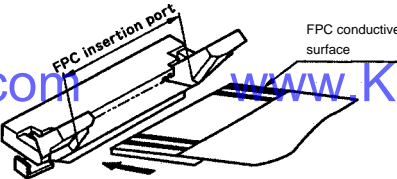
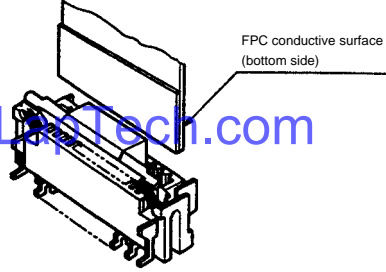
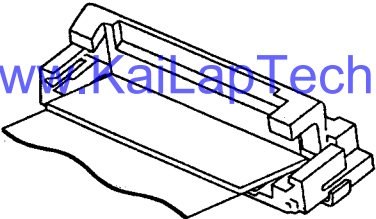
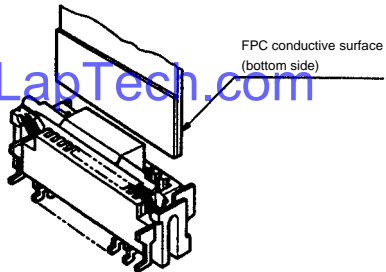
Pitch	Bottom Contact Type	Top Contact Type	Vertical mounting Type
0.5mm	 <p>FH12-**-S-0.5SH P.12</p> <p>Number of contacts 6, 8, 10, 11, 12, 13, 14, 15, 16, 17, 18, 19, 20, 22, 24, 25, 26, 28, 30, 32, 33, 34, 35, 36, 40, 45, 50, 53</p>	 <p>FH12A-**-S-0.5SH P.15</p> <p>Number of contacts 10, 12, 15, 16, 18, 20, 22, 24, 26, 28, 29, 30, 32, 33, 34, 36, 40, 42, 45, 50</p>	 <p>FH12-**-S-0.5SV P.16</p> <p>Number of contacts 10, 12, 13, 15, 16, 17, 18, 20, 22, 24, 26, 30, 32, 33, 34, 36, 40, 45, 49, 50, 60</p>
	<p>Type with Strengthened Lock Lever</p>		
	<p>FH12S-**-S-0.5SH P.13</p> <p>Number of contacts 30, 40, 45, 50, 53</p> <p>Type with 0.18mm FPC End Thickness</p>		
	<p>FH12F-**-S-0.5SH P.14</p> <p>Number of contacts 6, 8, 10, 12, 13, 14, 15, 16, 18, 20, 22, 24, 25, 26, 28, 30, 32, 34, 36, 40</p>		
1mm	 <p>FH12-**-S-1SH P.18</p> <p>Standard</p> <p>Number of contacts 5, 6, 7, 8, 9, 11, 12, 16, 17, 22, 26</p> <p>Eccentric</p> <p>Number of contacts 4, 6, 8, 10, 11, 14, 19, 24</p>	 <p>FH12-**-S-1SV P.19</p> <p>Number of contacts 6, 7, 8, 16, 20, 22, 24</p>	

0.5mm Pitch Bottom Contact Type

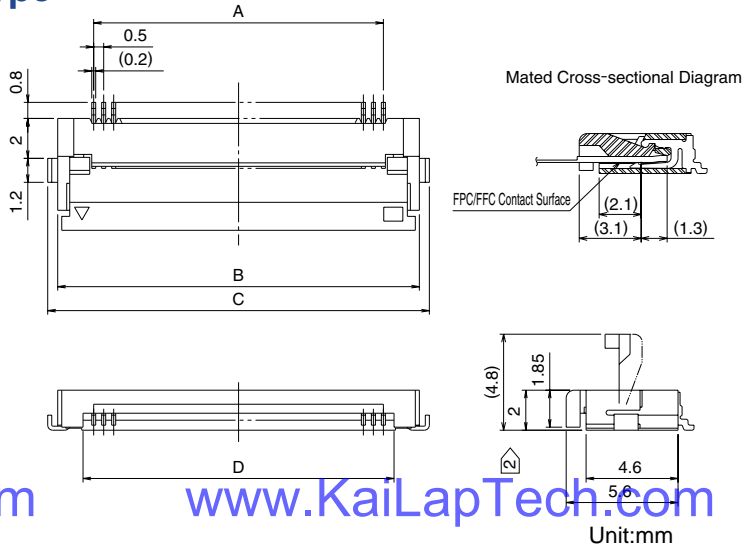

www.KaiLapTech.com

www.KaiLapTech.com

Part Number	CL No.	Number of Contacts	A	B	C	D	RoHS
FH12- 6S-0.5SH(55)	586-0582-5-55	6	2.5	6.1	7.1	3.57	YES
FH12- 8S-0.5SH(55)	586-0744-5-55	8	3.5	7.1	8.1	4.57	
FH12-10S-0.5SH(55)	586-0522-3-55	10	4.5	8.1	9.1	5.57	
FH12-11S-0.5SH(55)	586-0600-5-55	11	5	8.6	9.6	6.07	
FH12-12S-0.5SH(55)	586-0704-0-55	12	5.5	9.1	10.1	6.57	
FH12-13S-0.5SH(55)	586-0549-0-55	13	6	9.6	10.6	7.07	
FH12-14S-0.5SH(55)	586-0533-0-55	14	6.5	10.1	11.1	7.57	
FH12-15S-0.5SH(55)	586-0523-6-55	15	7	10.6	11.6	8.07	
FH12-16S-0.5SH(55)	586-0531-4-55	16	7.5	11.1	12.1	8.57	
FH12-17S-0.5SH(55)	586-0606-1-55	17	8	11.6	12.6	9.07	
FH12-18S-0.5SH(55)	586-0530-1-55	18	8.5	12.1	13.1	9.57	
FH12-19S-0.5SH(55)	586-0534-2-55	19	9	12.6	13.6	10.07	
FH12-20S-0.5SH(55)	586-0524-9-55	20	9.5	13.1	14.1	10.57	
FH12-22S-0.5SH(55)	586-0532-7-55	22	10.5	14.1	15.1	11.57	
FH12-24S-0.5SH(55)	586-0521-0-55	24	11.5	15.1	16.1	12.57	
FH12-25S-0.5SH(55)	586-0692-3-55	25	12	15.6	16.6	13.07	
FH12-26S-0.5SH(55)	586-0576-2-55	26	12.5	16.1	17.1	13.57	
FH12-28S-0.5SH(55)	586-0612-4-55	28	13.5	17.1	18.1	14.57	
FH12-30S-0.5SH(55)	586-0525-1-55	30	14.5	18.1	19.1	15.57	
FH12-32S-0.5SH(55)	586-0681-7-55	32	15.5	19.1	20.1	16.57	
FH12-33S-0.5SH(55)	586-0520-8-55	33	16	19.6	20.6	17.07	
FH12-34S-0.5SH(55)	586-0617-8-55	34	16.5	20.1	21.1	17.57	
FH12-35S-0.5SH(55)	586-0740-4-55	35	17.0	20.6	21.6	18.07	
FH12-36S-0.5SH(55)	586-0526-4-55	36	17.5	21.1	22.1	18.57	
FH12-40S-0.5SH(55)	586-0527-7-55	40	19.5	23.1	24.1	20.57	
FH12-45S-0.5SH(55)	586-0528-0-55	45	22	25.6	26.6	23.07	
FH12-50S-0.5SH(55)	586-0529-2-55	50	24.5	28.1	29.1	25.57	
FH12-53S-0.5SH(55)	586-0595-7-55	53	26	29.6	30.6	27.07	

Note ②

Note ②

Note ②

Note ②

Note 1 : Embossed tape reel packaging (2,000 pieces/reel).
 Order by number of reels.

Note ② : If there is no problem with the connector height, we recommend the type with the strengthened Flip-lock actuator (FH12S-*S-0.5SH).
 Standard type connector height: 2 mm
 Connector height of type with strengthened Flip-lock actuator: 2.4 mm

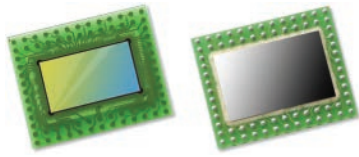

OS02C10 2-megapixel product brief



www.KaiLapTech.com

www.KaiLapTech.com

www.KaiLapTech.com

www.KaiLapTech.com



available in
a lead-free
package

Image Sensor Combines Ultra Low Light and Nyxel® NIR Technologies for Industry's Best

www.KaiLapTech.com Nighttime Camera Performance www.KaiLapTech.com

OmniVision's OS02C10 is a 2.9-micron, 2-megapixel image sensor with breakthrough ultra-low-light (ULL) technology. Combining ULL with OmniVision's industry-leading Nyxel® near-infrared (NIR) technology, the OS02C10 works equally well in all lighting conditions. It can detect incident light in both visible and NIR wavelengths and produce precise color and monochrome images for security applications such as remote surveillance cameras with AI for accurate facial recognition.

Nyxel® NIR technology infuses the OS02C10 with exceptional quantum efficiency (QE) of 60% at 850 nm and 40% at 940 nm, which is 2x to 4x better than competing devices. This enables the use of lower-power IR illumination in total darkness, resulting in an estimated 3x reduction in system-level power consumption. Additionally, 940 nm NIR lighting cannot be detected by the human eye in dark indoor settings, while 850 nm light is ideal for outdoor security cameras. The OS02C10's ability to capture crisp, clear images using undetectable 940 nm NIR light means that indoor security cameras will not disturb sleeping occupants, and can be easily concealed from intruders.

The amount of NIR light that a sensor requires to capture high-quality images can be quantified with a new metric called NIR SNR1, which takes into account the QE, pixel size and read noise. The OS02C10 achieves an SNR1_{850nm} of 23 nW/cm² and an SNR1_{940nm} of 31 nW/cm², which means designers can reduce IR illumination to consume 2x to 4x less power compared to the competitors' sensors, for the same environment and over the same image-detection range.

The OS02C10 has a superior low-noise design, achieving an SNR1 of 0.16 lux while producing high definition 1080p images. OmniVision's proprietary dual-conversion-gain technology allows this sensor to achieve the industry's best ULL performance, while the 3-frame staggered shutter minimizes motion artifacts and enables a high dynamic range (HDR) of 120 dB. Additionally, these technologies are easily upgradable to 2K and 4K resolution as security systems begin their transition to higher-quality displays.

Find out more at www.ovt.com.



OmniVision.

Applications

- Security Camera
- High Resolution Consumer Camera
- Action Camera

Product Features

- QE enhancement in NIR range
- support for image size:
 - 1920 x 1080
 - VGA
 - QVGA, and any cropped size
- high dynamic range
- high sensitivity
- programmable conversion gain
- image sensor processor functions:
 - defective pixel cancellation
 - automatic black level correction, etc.
- pixel data: 12b RAW RGB
- SCCB for register programming
- programmable GPIOs
- high speed serial data transfer with MIPI CSI-2 or LVDS
- external frame synchronization capability
- embedded temperature sensor
- one-time programmable (OTP) memory

OS02C10

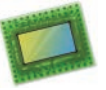

Ordering Information

- OS02C10-J70A-Z (color, lead-free)
70-pin fan-out package

Product Specifications

- active array size: 1920 x 1080
- maximum image transfer rate:
 - 40X3 fps @ 1080p in 10-bit
 - 30X3 fps @ 1080p in 12-bit
- power supply:
 - analog: 2.8V
 - digital: 1.1V
 - I/O pins: 1.8V
- temperature range:
 - operating: -30°C to +85°C junction temperature
- output interfaces:
 - up to 4-lane MIPI CSI-2 or LVDS
- lens size: 1/2.8"
- lens chief ray angle: 9° linear
- output formats: linear output, dual exposure HDR (long and short), 3-exposure HDR (long, short, and very short), conversion gain programmable in each channel
- scan mode: progressive
- shutter: rolling shutter
- pixel size: 2.9 μm x 2.9 μm
- image area: 5614.4 μm x 3178.4 μm

Functional Block Diagram

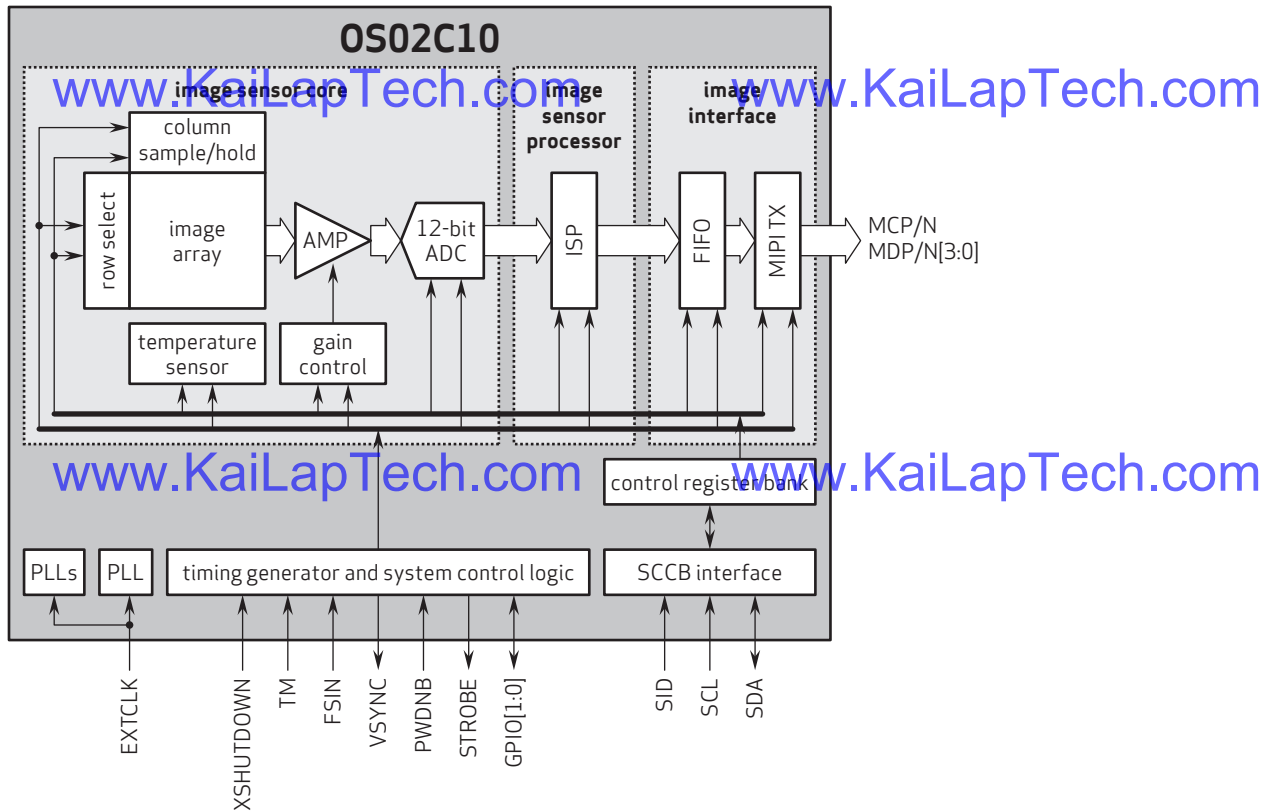

4275 Burton Drive
Santa Clara, CA 95054
USA

Tel: + 1 408 567 3000
Fax: + 1 408 567 3001
www.ovt.com

OmniVision reserves the right to make changes to their products or to discontinue any product or service without further notice. OmniVision, the OmniVision logo, and Nixel are registered trademarks of OmniVision Technologies, Inc. All other trademarks are the property of their respective owners.



OmniVision



Referenztable für die Pinbelegungsdefinition des Kameramoduls

OmniVision Sony Himax Samsung On-Semi Aptina Himax GalaxyCore PixArt Bildsensoren	
Pin Signal	Beschreibung
DGND GND	Masse für digitale Schaltung
AGND	Masse für analoge Schaltung
PCLK DCK	DVP-PCLK-Ausgang
XCLR PWDN XSHUTDOWN STANDBY	Abschalten aktiv hoch mit internem Pulldown-Widerstand
MCLK XVCLK XCLK INCK	Systemeingangsuhr
RESET RST	Aktiv Low mit internem Pull-up-Widerstand zurücksetzen
NC NULL	keine Verbindung
SDA SIO_D SIOD	SCCB-Daten
SCL SIO_C SOIC	SCCB-Eingangstakt
VSYNC XVS FSYNC	DVP-VSYNC-Ausgang
HREF XHS	DVP-HREF-Ausgang
DOVDD	Strom für E/A-Schaltung
AFVDD	Strom für VCM-Schaltung
AVDD	Strom für analoge Schaltung
DVDD	Strom für digitale Schaltung
STROBE FSTROBE	Strobe-Ausgang
FSIN	Synchronisieren Sie das VSYNC-Signal vom anderen Sensor
SID	SCCB letzte Bit-ID-Eingabe
ILPWM	mechanische Shutter-Ausgangsanzeige
FREX	Rahmenbelichtung / mechanischer Verschluss
GPIO	Allzweckeingänge
SLASEL	I2C-Slave-Adresse auswählen
AFEN	CEN-Chip aktivieren aktiv hoch auf VCM-Treiber-IC
MIPI Schnittstelle	
MDN0 DN0 MD0N DATA_N DMO1N	MIPI 1st negative Ausgabe der Datenspur
MDP0 DP0 MD0P DATA_P DMO1P	MIPI 1st positiver Ausgang der Datenspur
MDN1 DN1 MD1N DATA2_N DMO2N	MIPI 2nd negative Ausgabe der Datenspur
MDP1 DP1 MD1P DATA2_P DMO2P	MIPI 2nd positiver Ausgang der Datenspur
MDN2 DN2 MD2N DATA3_N DMO3N	MIPI 3rd negative Ausgabe der Datenspur
MDP2 DP2 MD2P DATA3_P DMO3P	MIPI 3rd positiver Ausgang der Datenspur
MDN3 DN3 MD3N DATA4_N DMO4N	MIPI 4th negative Ausgabe der Datenspur
MDP3 DP3 MD3P DATA4_P DMO4P	MIPI 4th positiver Ausgang der Datenspur
MCN CLKN CLK_N DCKN	MIPI Uhr negativer Ausgang
MCP CLKP MCP_CLK_P DCKN	MIPI Takt positiver Ausgang
DVP Parallel Schnittstelle	
D0 DO0 Y0	DVP Datenausgabeport 0
D1 DO1 Y1	DVP Datenausgabeport 1
D2 DO2 Y2	DVP Datenausgabeport 2
D3 DO3 Y3	DVP Datenausgabeport 3
D4 DO4 Y4	DVP Datenausgabeport 4
D5 DO5 Y5	DVP Datenausgabeport 5
D6 DO6 Y6	DVP Datenausgabeport 6
D7 DO7 Y7	DVP Datenausgabeport 7
D8 DO8 Y8	DVP Datenausgabeport 8
D9 DO9 Y9	DVP Datenausgabeport 9
D10 DO10 Y10	DVP Datenausgabeport 10
D11 DO11 Y11	DVP Datenausgabeport 11



your **BEST** camera module partner

Kameraanwendungen



www.KaiLapTech.com

www.KaiLapTech.com



www.KaiLapTech.com

www.KaiLapTech.com



www.KaiLapTech.com

www.KaiLapTech.com





Kamera-Zuverlässigkeitstest

Reliability Inspection Item		Testmethode	Akzeptanzkriterium	
Kategorie	Artikel			
Umwelt	Lager Temperatur	Hoch 60°C 96 Std	Temperaturkammer	Keine anormale Situation
		Niedrig -20°C 96 Std	Temperaturkammer	Keine anormale Situation
	Betriebs Temperatur	Hoch 60°C 24 Std	Temperaturkammer	Keine anormale Situation
		Niedrig -20°C 24 Std	Temperaturkammer	Keine anormale Situation
	Feuchtigkeit	60°C 80% 24 Std	Temperaturkammer	Keine anormale Situation
	Thermischer Schock	Hoch 60°C 0.5 Std Niedrig -20°C 0.5 Std Radfahren rein 24 Std	Temperaturkammer	Keine anormale Situation
Physisch	Falltest (Im freien Fall)	Ohne Verpackung 60cm	10 Mal auf Holzboden	Elektrisch funktionsfähig
		Mit Paket 60cm	10 Mal auf Holzboden	Elektrisch funktionsfähig
	Vibrations Test	50Hz X-Axis 2mm 30 Minuten	Vibrationstisch	Elektrisch funktionsfähig
		50Hz Y-Axis 2mm 30 Minuten	Vibrationstisch	Elektrisch funktionsfähig
		50Hz Z-Axis 2mm 30 Minuten	Vibrationstisch	Elektrisch funktionsfähig
	Zugfestigkeit des Kabels Krafttest	Gewicht laden 4 kg 60 Sekunden Radfahren rein 24 Std	Zugprüfmaschine	Elektrisch funktionsfähig
Elektrisch	ESD-Test	Kontaktaufnahme 2 KV	ESD-Prüfmaschine	Elektrisch funktionsfähig
		Luftentladung 4 KV	ESD-Prüfmaschine	Elektrisch funktionsfähig
	Alterungstest	On/Off 30 Sekunden Radfahren rein 24 Std	Stromschalter	Elektrisch funktionsfähig
	USB-Anschluss	On/Off 250 Mal	Einstecken und ausstecken	Elektrisch funktionsfähig





Inspektionsgegenstand		Untersuchungsmethode	Inspektionsstandard	
Kategorie	Artikel			
Aussehen	FPC oder PCB	Farbe	Das bloße Auge	Größere Unterschiede sind nicht zulässig.
		Zerrissen/gehackt werden	Das bloße Auge	Das Freilegen von Kupferrissen ist nicht zulässig.
		Markierung	Das bloße Auge	Klar, erkennbar (innerhalb von 30 cm Entfernung)
	Halterin	Kratzer	Das bloße Auge	Die Freilegung von Rissen im Inneren ist nicht zulässig
		Lücke	Das bloße Auge	Erfüllen Sie den Höhenstandard
		Schraube	Das bloße Auge	Stellen Sie sicher, dass Schrauben vorhanden sind (falls vorhanden)
		Schaden	Das bloße Auge	Die Freilegung von Rissen im Inneren ist nicht zulässig
	Linse	Kratzen	Das bloße Auge	Keine Auswirkung auf den Auflösungsstandard
		Kontamination	Das bloße Auge	Keine Auswirkung auf den Auflösungsstandard
		Ölfilm	Das bloße Auge	Keine Auswirkung auf den Auflösungsstandard
Abdeckband		Das bloße Auge	Kein Problem beim Aussehen.	
Funktion	Bild	Keine Kommunikation	Testboard	Nicht erlaubt
		Helles Pixel	Tafel	Im Image Center nicht erlaubt
		Dunkles Pixel	Weißer Tafel	Im Image Center nicht erlaubt
		Verschwommen	Das bloße Auge	Nicht erlaubt
		Kein Bild	Das bloße Auge	Nicht erlaubt
		Vertikale Linie	Das bloße Auge	Nicht erlaubt
		Horizontale Linie	Das bloße Auge	Nicht erlaubt
		Kleines Leck	Das bloße Auge	Nicht erlaubt
		Blinkendes Bild	Das bloße Auge	Nicht erlaubt
		Prellung	Inspektionslehre	Nicht erlaubt
		Auflösung	Diagramm	Folgt dem Diagrammstandard für ausgehende Inspektionen
		Farbe	Das bloße Auge	Kein Problem
		Lärm	Das bloße Auge	Nicht erlaubt
		Ecke dunkel	Das bloße Auge	Weniger als 100 x 100 Pixel
Farbauflösung	Das bloße Auge	Kein Problem		
Abmessungen	Höhe	Das bloße Auge	Befolgt Zulassungsdatenblatt	
	Breite	Das bloße Auge	Befolgt Zulassungsdatenblatt	
	Länge	Das bloße Auge	Befolgt Zulassungsdatenblatt	
	Gesamt	Das bloße Auge	Befolgt Zulassungsdatenblatt	



KLT-Paketlösungen

KLT Kameramodul

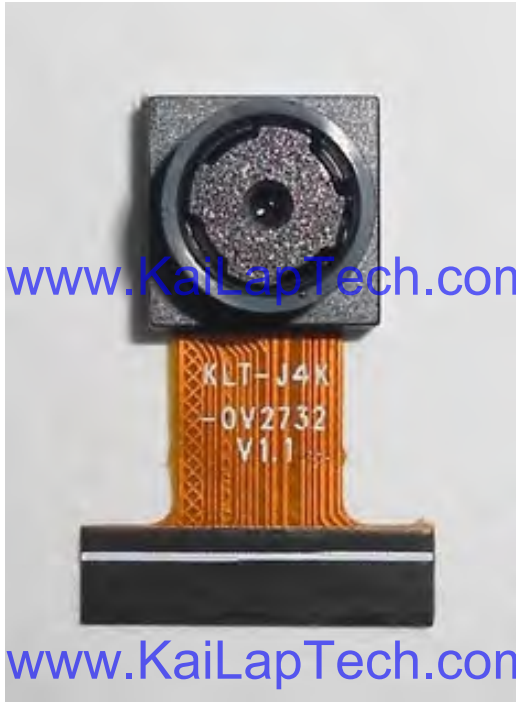

Komplett mit Linsenschutzfolie



Tablett mit Gitter und Raum



Legen Sie die Kameras auf das Tablett



Paketlösung für Kameramodule

Volles Tablett mit Cameras

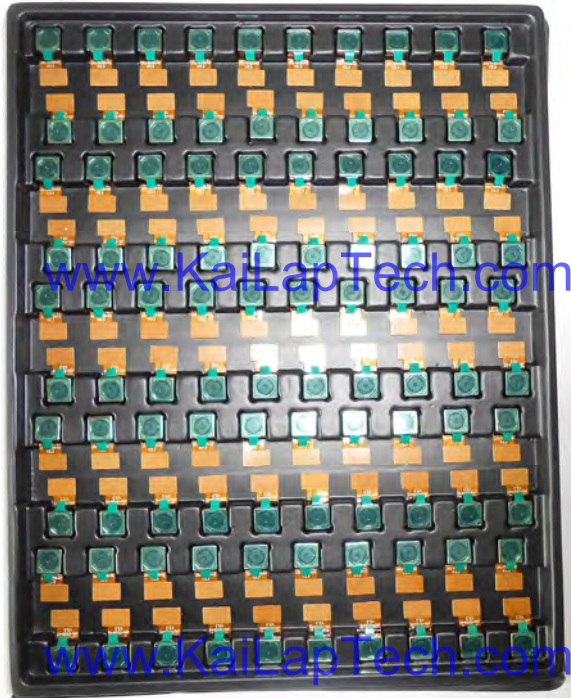

Abdeckschale mit Deckel



In Antistatikbeutel stecken



Staubsaugen Sie den antistatischen Beutel

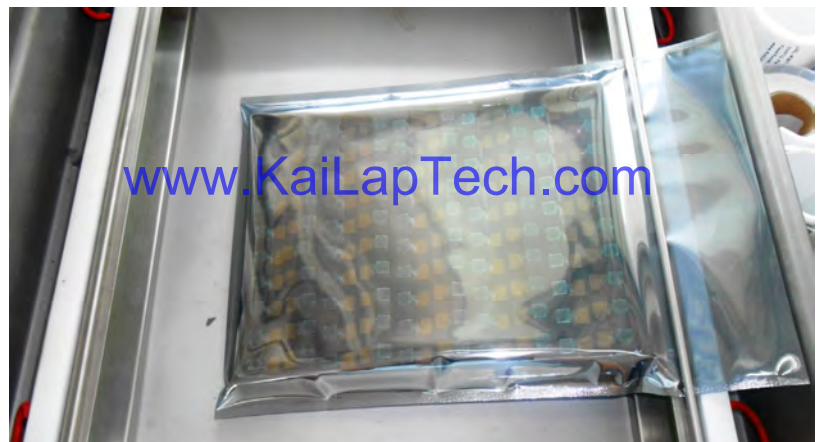



Paketlösung für Kameramodule

Versiegelter Vakuumbbeutel mit Etiketten

1. Modell und Beschreibung 2. Menge 3. Versanddatum 4. Achtung





Paketlösung für große Bestellungen

Schaumstoffplatten zwischen
die Tablettts legen



Schaumstoffplatten sind etwas
größer als Tablettts



www.KaiLapTech.com

Legen Sie Schaumstoffplatten und
Tablettts in die Schachtel



www.KaiLapTech.com

Schaumstoffplatten sind eng anliegende Box





Paketlösung für kleine Bestellungen

Legen Sie die Schaumstoffplatten und Tablett in die kleine Schachtel

Schaumstoffplatten passen gut in die kleine Box



www.KaiLapTech.com

www.KaiLapTech.com

Paket in kleiner Box für den Versand

Legen Sie kleine Kartons in größere Kartons





your **BEST** camera module partner

Carbon Box Paketlösung

Verschließen Sie die Carbonbox

Beschriftete Schachtel mit Endverpackung



- Versandfertige Karbonbox**
1. Lieferadresse und Telefonnummer
 2. Box-Nr. und Versanddatum
 3. Zerbrechliche Vorsicht



Lösung für Musterbestellungspakete

Legen Sie die Probe in einen kleinen antistatischen Beutel



Stecken Sie die Anschlüsse in den kleinen antistatischen Beutel



Musteretiketten auf dem kleinen Beutel

1. Kameramodul oder Anschlussmodell 2. Lieferdatum und Menge 3. Achtung





Steckverbinder Paketlösung für große Bestellungen

Steckverbinder in einem Rad



Steckverbinder im Rad beschriftet



Das Rad passt perfekt in die Box



Steckerbox versandfertig



Unternehmen Kai Lap Technologies (KLT)

Kai Lap Technologies Group Limited. (KLT) wurde 2009 gegründet und ist ein technologiegetriebener Hersteller der nächsten Generation, der sich auf Forschung, Design und Produktion von Audio- und Videoprodukten spezialisiert hat. KLT verfügt über 20.000 Quadratfuß automatisierte Fabriken mit 100 Mitarbeitern und einem jährlichen Durchsatz von 30.000.000 Kameraeinheiten.

KLT bietet OEM-, ODM-Design, Auftragsfertigung und baut die Kameraprodukte. Sie können uns die Anforderungen auch mit einem Handentwurf übermitteln, unser Vertrieb und unsere Technik arbeiten zusammen, um Ihre Anforderungen zu erfüllen. Wir verstehen uns als Ihr langfristiger Partner bei der Entwicklung praktischer und innovativer Lösungen.

Unser Team deckt alles von der ersten Konzeptentwicklung bis zum Massenprodukt ab. KLT ist spezialisiert auf kundenspezifisches Kameradesign, Rohmaterial, Elektrotechnik, Firmware-/Softwareentwicklung, Produkttests und Verpackungsdesign. Unsere erfahrenen strategischen Versorgungssysteme bieten eine robuste und zuverlässige Fertigungskapazität für Aufträge unterschiedlicher Größe.

www.KaiLapTech.com

www.KaiLapTech.com



Eingeschränkte Garantie

KLT gewährt die folgende eingeschränkte Garantie, wenn Sie das/die Produkt(e) direkt von der Firma KLT oder von der Website von KLT, www.KaiLapTech.com, gekauft haben. Produkte, die von anderen Verkäufern oder Quellen gekauft wurden, fallen nicht unter diese beschränkte Garantie. KLT garantiert, dass das/die Produkt(e) bei normalem Gebrauch für einen Zeitraum von einem (1) Jahr ab dem Datum, an dem Sie das Produkt erhalten („Garanzzeitraum“), frei von Material- und Verarbeitungsfehlern sind.

Für alle Produkte, die während des Garanzzeitraums Material- oder Verarbeitungsfehler enthalten oder entwickeln, wird KLT nach eigenem Ermessen entweder: (i) die Produkte reparieren; (ii) das/die Produkt(e) durch ein neues oder generalüberholtes Produkt(e) ersetzen (Ersatzprodukt(e) sind von identischem Modell oder funktionell gleichwertig); oder (iii) Ihnen den Preis erstatten, den Sie für das/die Produkt(e) gezahlt haben.

Diese eingeschränkte Garantie von KLT ist ausschließlich auf Reparatur und/oder Ersatz zu den oben genannten Bedingungen beschränkt. KLT ist nicht zuverlässig oder verantwortlich für nachfolgende Ereignisse.





CMOS CAMERA MODULES



your BEST camera module partner

KLT Stärke

Leistungsstarke Fabrik



Professioneller Service



Versprochene Lieferung



www.KaiLapTech.com sales@KaiLapTech.com Tel: (852) 6908 1256 Fax: (852) 3017 6778

All rights reserved @ Kai Lap Technologies Group Ltd. Specifications subject to change without notice.